

HOW TO

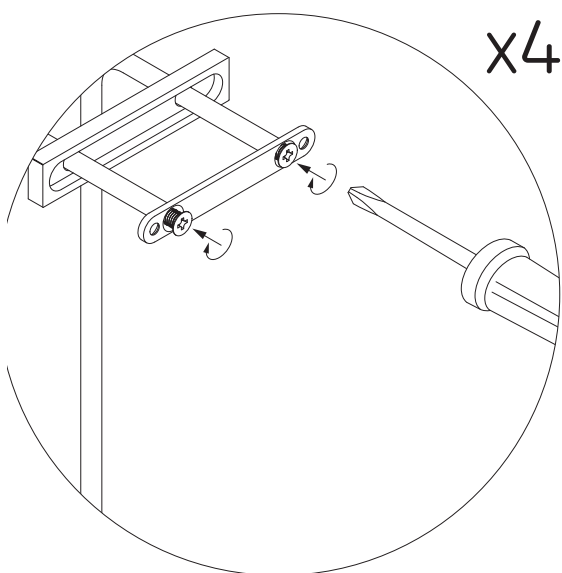

x4

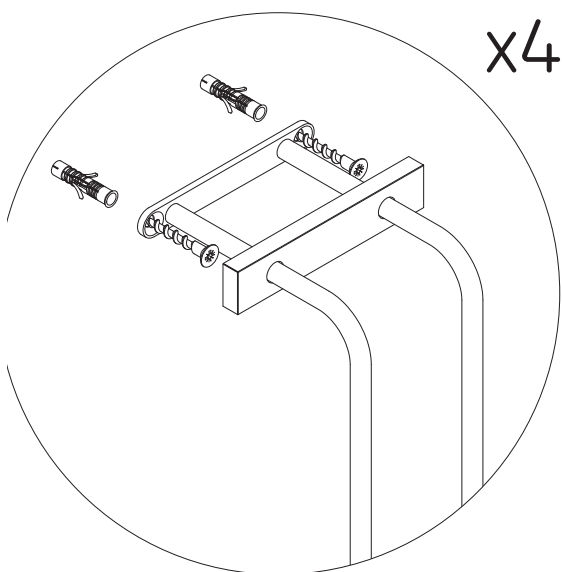

x4

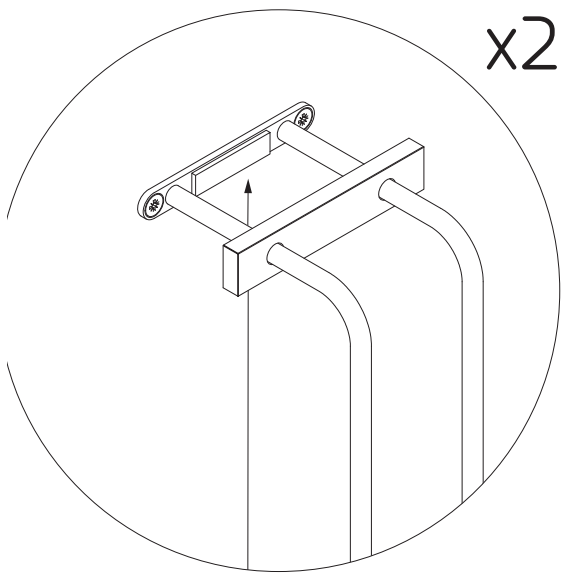
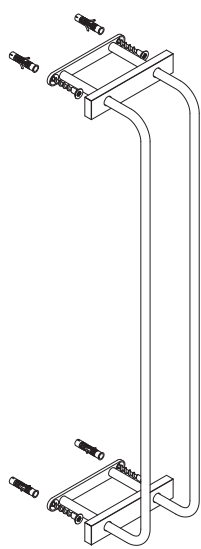

x2

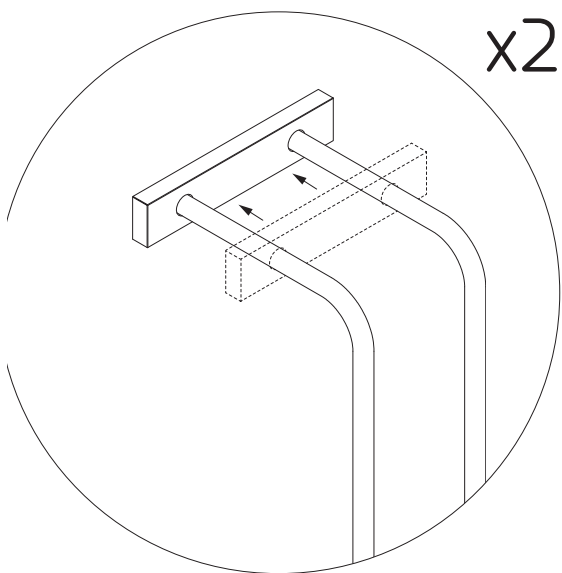
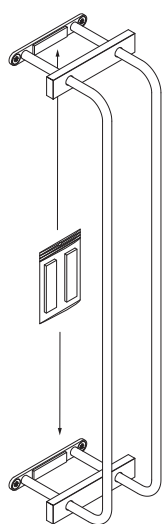

x2

